

Solatube® Daylight Dimmer Installation Instructions

Please read all warnings and instructions before beginning installation.

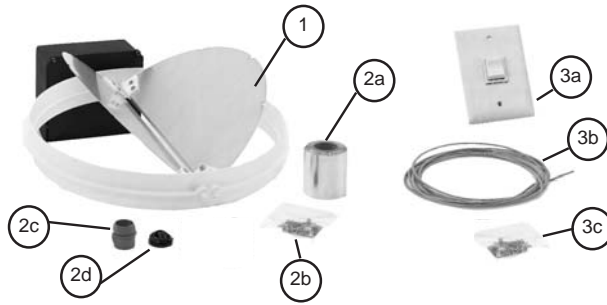

OVERVIEW

These instructions are for installing and wiring the Solatube Daylight Dimmer. Units are designed to operate in a temperature range of -20°F (-29°C) to 130°F (54°C). If ambient temperatures are outside of these values or the environment is very humid, wrap the junction box with an insulation blanket with a vapor barrier.

Step 1. Place Daylight Dimmer atop the bottom tube of your 10" or 14" Solatube (**Diagram A**). (For 21" Solatube (**Diagram B**), place the Daylight Dimmer atop the round sleeve of the transition box). Junction box should be oriented towards the closest source of power with UL label arrow pointing up. Using two 3/8" (9mm) screws, fasten Solatube Daylight Dimmer to bottom tube or transition box sleeve through pre-drilled fastening holes in Daylight Dimmer (**Diagram B**). Apply foil tape around perimeter of Daylight Dimmer connection.

Step 2. Connect extension tubing to top of Solatube Daylight Dimmer with screws and tape. Note: For 10" and 14" Daylight Dimmers, the extension tube should be assembled with large diameter end inserted into top segment of Solatube Daylight Dimmer. For the 21" Solatube, the bottom angle adapter inserts into the top of the Daylight Dimmer. Align seam of extension tube with axle on Daylight Dimmer to avoid binding butterfly baffle. Return to Solatube standard installation instructions from this point on to continue with skylight installation.

DC Control Daylight Switch and Dimmer

Step 3. Position switch on wall; minimum 38" (1.5 M) above floor; within visual sight of the Solatube - Daylight Dimmer assembly; but away from moving parts. Run cable (4 conductor 22 gauge with red, black, white and green colors) from the Daylight Dimmer Switch to the Daylight Dimmer junction box. **Diagram C** illustrates the four terminal locations and their respective conductor. **Diagram D** provides a completed overview of the entire wired assembly for the Solatube Daylight Dimmer junction box. Using pliers, clamp cables in 1/2-inch strain relief and press into junction box hole from the outside. If multiple units are connected, include cables from terminals 5 and 6.

DC Control (Multiple Units/Daisy-Chain)

Step 4. Controlling multiple (two or more) units from one master will switch requires the following: Use (2) conductor 22 gauge cable (Red and Black, not included in kit).

At Preceding unit Junction Box: (**Diagram F1**). At Succeeding unit Junction Box: (**Diagram F2**). Using pliers, clamp cables in 1/2-inch strain relief and press into junction box hole from the outside.

Supply - AC to Power Supply For single and/or multiple installations. Electrical disconnect such as fuse or breaker switch must be utilized in supply circuit and disconnected during installation to protect personnel and Daylight Dimmer. Rating: 90 - 277 V, 50/60 Hz, 30 A (Max). Wire Size: 22 to 12 ga. **Connect:** Conductors to labeled terminal block on Power Supply (**Diagram Q**).

For North America:

- Black Conductor to Terminal (L) Line
- White Conductor to Terminal (N) Neutral
- Green Conductor to Terminal (G) Ground/Earth

For Europe:

- Brown Conductor to Terminal (L) Line
- Light Blue Conductor to Terminal (N) Neutral
- Green/Yellow Conductor to Terminal (G) Ground/Earth

ADDENDUM TO PARTS LIST

	Quantity
1. Daylight Dimmer	(1)
2. Seal and Fastener Kit	
a. Foil Tape - 2" (50mm) wide x 72 (1.8mm)	(1)
b. Screws (Phillips) # 8 x 3/8" (9mm)	(4)
c. Romex connector	(2)
d. Strain Relief 1/2" (13mm)	
3. Daylight Dimmer Switch (sold separately).	
a. Switch: DPDT Momentary, Rocker, Snap-In (Min.: 5V, 100mA with Cover Plate)	
b. Cable:	
i. Switch Circuit: (4) Conductor, Stranded Copper, 22ga, (Green, White, Red and Black) 90°.	
ii. Daisy Chain (Multiple Unit) Circuit: (2) Conductor, Stranded Copper, 22ga, (Red and Black) 90°.	
c. Screws: (2) #6MS Recessed Oval Slotted	

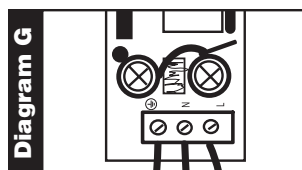
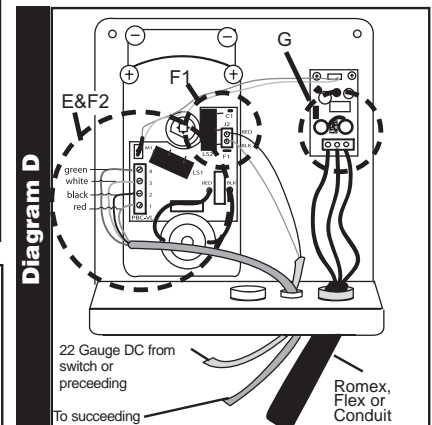
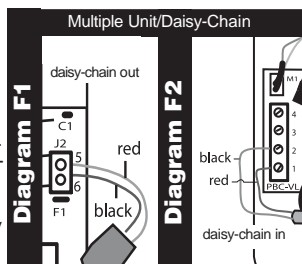
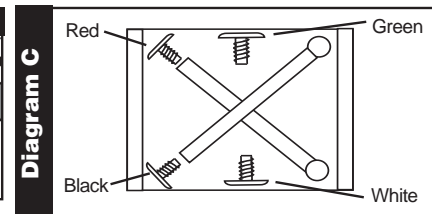
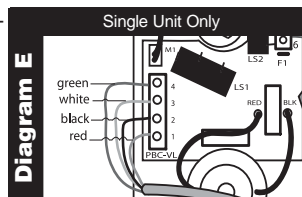
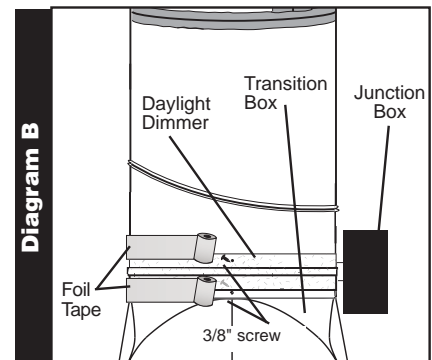
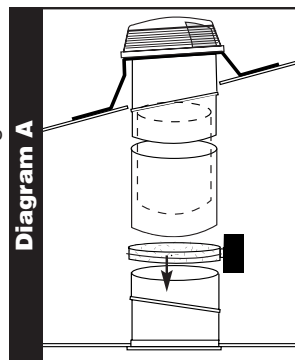



WARNING



Do not proceed with the installation until you have read the entire instructions, including these warnings.

Solatube (seller) assumes no responsibility or obligation whatsoever for the failure of an architect, contractor, installer, or building owner to comply with all applicable laws, ordinances, building codes, energy codes, fire and safety codes and requirements, roof warranties and adequate safety precautions. Installation of this product should be attempted only by individuals skilled in the use of the tools and equipment necessary for installation. Protect yourself and all persons and property during installation. If you have any doubt concerning your competence or expertise, consult a qualified expert before proceeding.

Install at your own risk!

Solatube product installations may be dangerous and include the potential for death, personal injury and property damage. The hazardous conditions include but are not limited to the following:

- Install Solatube Daylight Dimmer only on a properly aligned Solatube Skylight.
- Before installing, servicing or cleaning unit, switch power off at service panel and lock service panel to prevent power from becoming switched on accidentally. When the service disconnecting means cannot be locked, securely fasten a prominent warning device such as a tag to the service panel.
- Use only UL recognized components approved for this listing.
- During installation, the Solatube's reflective tubes may focus sunlight, causing intense heat or fire. Remove protective film only after the parts have been installed. Prior to and during installation, do not leave tubes in contact with combustible materials or unattended, especially near direct sunlight. Avoid skin burns.
- Sheet metal edges may be sharp. Use protective gloves to avoid lacerations.
- Skylight installations require climbing and working at dangerous heights, including on ladders, scaffolding, roofs and in attic spaces. Risk of death, personal injury and property damage may result from a fall, or from falling objects. Use extreme caution to minimize risk of accidental injury, including, but not limited to the following procedures:

Clear area below your work space of all people, animals and other items.

Avoid working on surfaces that are slippery or wet.

Use foot-wear with excellent traction.

Use only strong, well supported ladders.

Work only in calm dry weather.

When in the attic, ensure that your weight is supported at all times with structurally sound framing; dry wall material is not designed to carry a person's weight.

- To reduce the risk of fire, electric shock, and personal injury; basic safety precautions should always be followed when using electric tools, including always wearing safety goggles or other suitable eye protection, and ensuring work area is clear of all electrical wires, gas pipes, water pipes, and other obstacles.
- When working in the attic or other dusty areas, use of a mask or respirator is recommended to avoid lung irritation. Attic spaces may be dark, confined, and subject to extreme temperatures. Beware of sharp protruding objects. Do not attempt installation without having someone within range of your voice or close enough to come to your aid if necessary.
- The tubular skylight is not designed to withstand the weight of a person, tools or other objects. Walking or placing objects on the skylight could cause personal injury and property damage. If the dome of the skylight is broken or cracked, or if the skylight is otherwise damaged, the structural capacity may be weakened, and the skylight should be repaired immediately. For safe installation and use, do not deviate from these installation instructions.

Warranty Information

For all Solatube products purchased or delivered hereunder, Solatube International, Inc. warrants they are free from defects of workmanship and/or material for a period of time from the date of purchase as noted hereafter:

- 5 years on electrical and motor
- 10 years on all other components, including metal housing, roof flashing bases, plastic, rubber or metal seals, gaskets and fasteners.

Should any products be determined by Solatube to be defective, at the option of Solatube, such products will be replaced or repaired and returned to Buyer free from defect. Buyer will give notice of any such defect to Solatube within thirty (30) days of discovery of such defects. Buyer will provide proof of purchase over life of warranty on all warranty claims as required. Except as expressly set forth herein, the products are provided "as is", without any warranty, express or implied, including but not limited to all warranties of merchantability and fitness for a particular purpose; and any such warranties are hereby expressly disclaimed.

In no event will Solatube be liable for loss of profits, indirect, special incidental, consequential or other similar damages, including but not limited to any claim or demand arising out of the installation, existence, furnishing or functioning of any of the products or use by any breach of warranty for improper installation of these products. To the fullest extent allowed by law, Solatube's liability to all Buyers for all claims with respect to the products will be limited to the lesser of (a) the cost of replacing the products; (b) the cost of obtaining equivalent products; or (c) the cost of having products repaired.